

Name • Nom • Nome • Naam • Nazwa • Jméno •
Názov • Név • Denumire • Isim • Название

Nr. • No. • N° • Номер • Č • Sz

Typ • Type • Tip • Tipus • Tipo • Тип

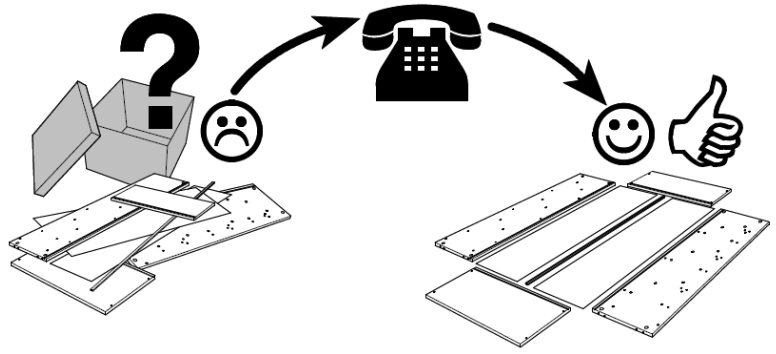
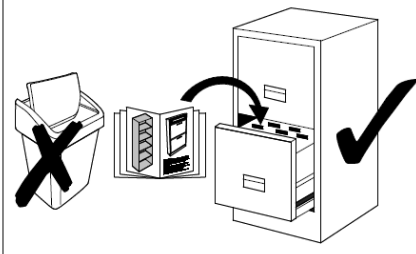

0
10
20
30
40
50
60
70
80
90
100
110
120
130
140
150
160
170
180
190
200

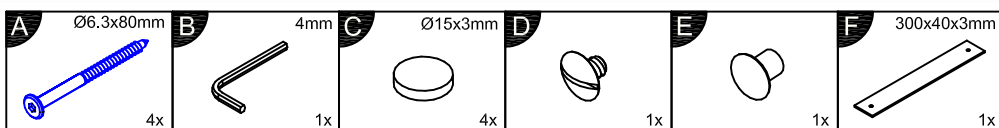
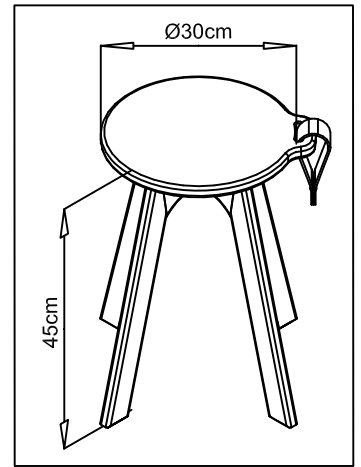
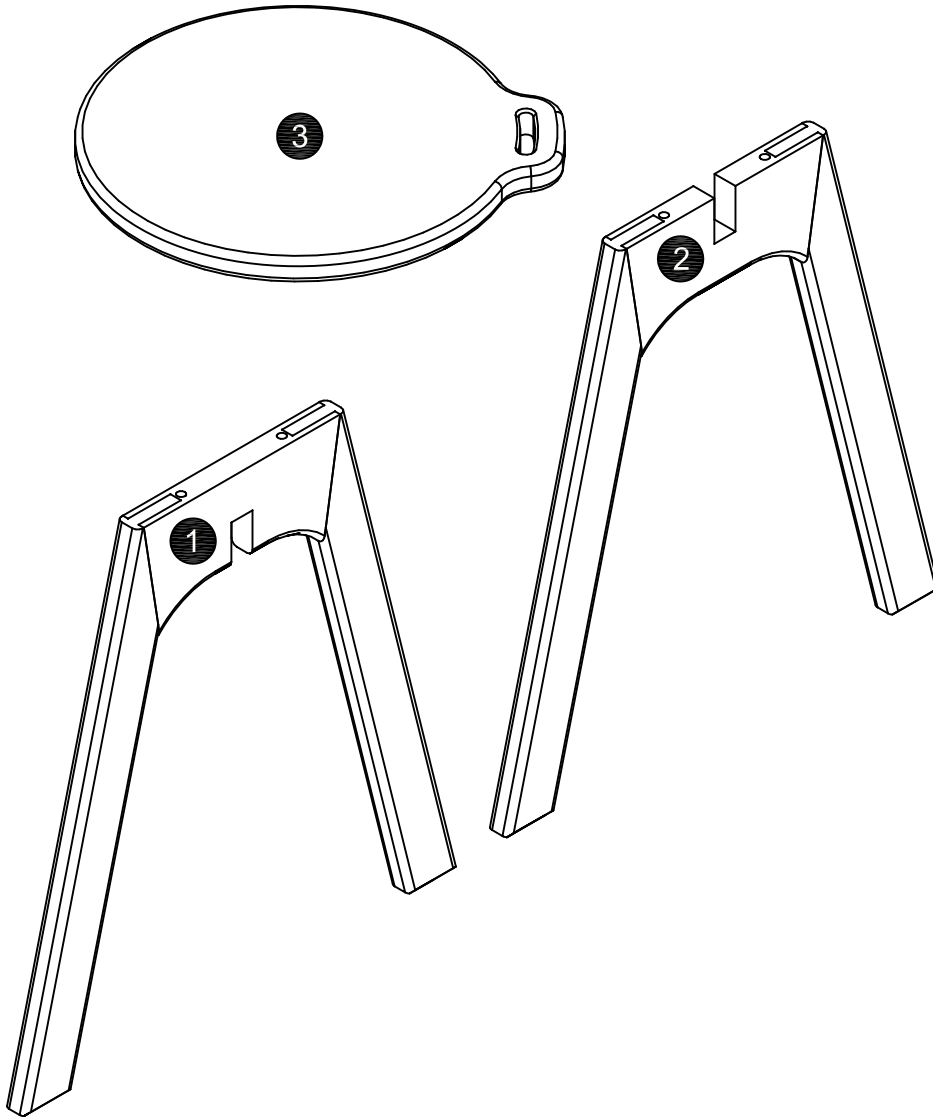

1

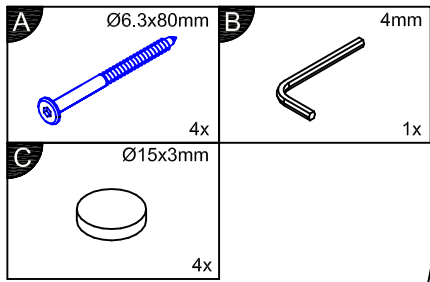

1

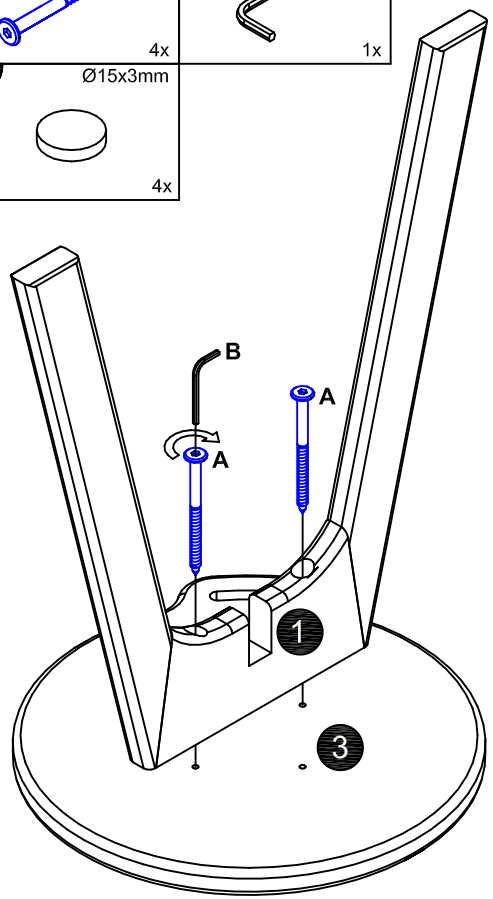

2

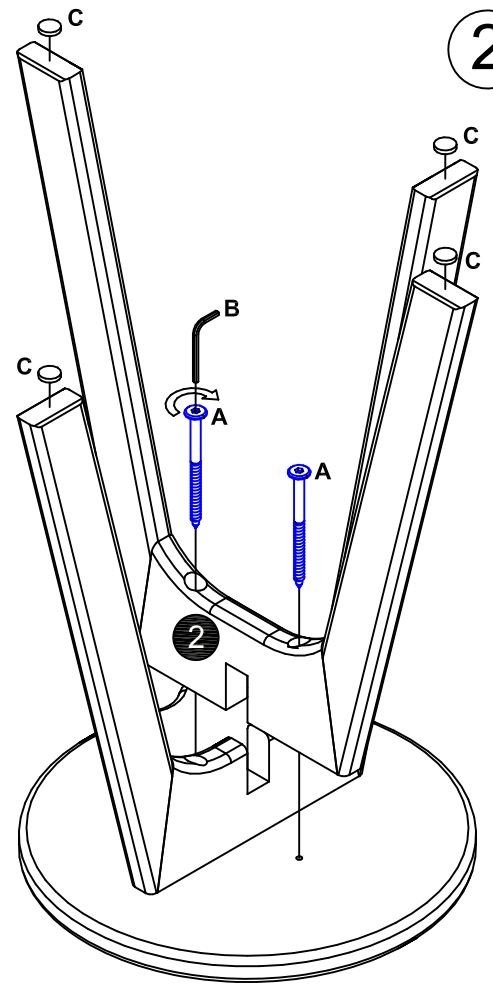

2

